

COAXIAL SPINNERET



DESCRIPTION

Coaxial spinneret is a powerful research instrument to make core-shell nanofibers as well as hollow nanofibers. The spinneret is made by chemical resistant plastic material and the needles are made by stainless steel. The system can be easily dismantled for cleaning and maintenance operations. For electrospinning process the system can be easily hosted on adjustable stand support.

To obtain several diameters of fibers in order to address your target, the device can be assembled with different combination of needles.

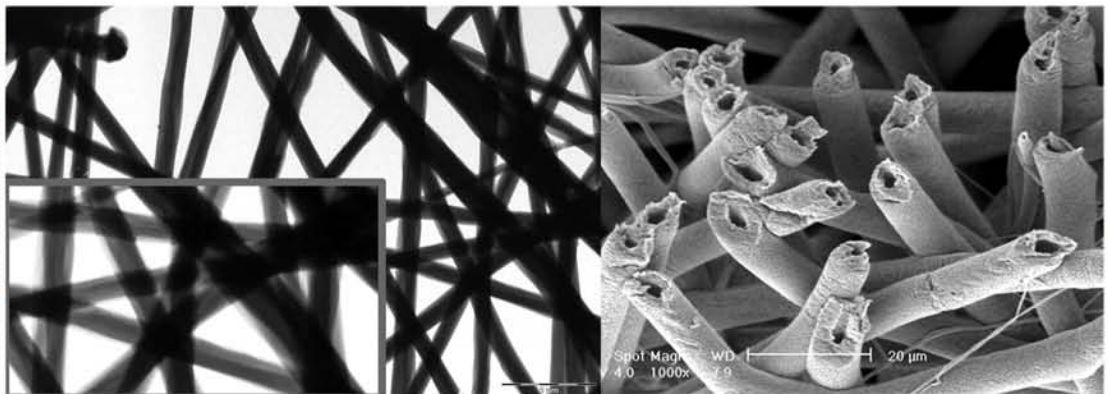

Example of core/shell and hollow fibers produced by Coaxial spinneret

DISCLAIMER: The contents and information contained in this brochure are intended for general marketing purposes only and should not be relied upon by any person as being complete or accurate.

MIB srl will not accept any liability suffered or incurred by any person arising out of or in connection with any reliance on the content of or information contained in this brochure.



MIB srl SOCIETÀ BENEFIT

Bologna (Italy)

info@mib40.com

COAXIAL SPINNERET

TECHNICAL DATA

Depending on the core and shell fluid characteristics, the optimal needle diameter for coaxial nanofibers fabrication can vary. Coaxial spinneret allows user to mount different inner and outer needles and combine them to obtain multiple configurations. After a deep study of the coaxial electrospinning state-of-the-art, Spinbow decided to offer 4 diameter possibilities for the inner needle and 5 different possibilities for the outer one. The chosen diameters can be seen on the chart below. Needles with different diameters from the ones we propose can also be ordered upon request.

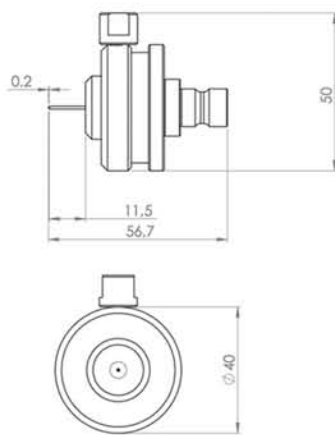

SHELL NEEDLES				
Internal Diameter x External Diameter (mm)				
S1	S2	S3	S4	S5
0.60	0.80	1.20	1.65	2.05
x	x	x	x	x
0.90	1.20	1.50	2.20	2.60

CORE NEEDLES	Internal Diameter x External Diameter (mm)								
	C1	C2	C3	C4					
C1	0.22 x 0.40								
C2	0.30 x 0.55								
C3	0.55 x 0.80								
C4	0.80 x 1.20								

DISCLAIMER: The contents and information contained in this brochure are intended for general marketing purposes only and should not be relied upon by any person as being complete or accurate.

MIB srl will not accept any liability suffered or incurred by any person arising out of or in connection with any reliance on the content of or information contained in this brochure.



MIB srl SOCIETÀ BENEFIT

Bologna (Italy)

info@mib40.com



COAXIAL SPINNERET

WASTE MATERIAL REDUCTION

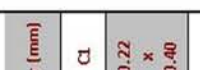
In order to reduce the waste material in core or shell needle, both fittings of Coaxial can be properly exchanged as schematized in the following tables. Both configurations can be hosted on the same needle holder.

Minimal Shell Volume installation					SHELL NEEDLES				
					Internal Diameter x External Diameter (mm)				
					S1	S2	S3	S4	S5
					0.60	0.80	1.20	1.65	2.05
					x	x	x	x	x
					0.90	1.20	1.50	2.20	2.60
					○	○	○	○	○
CORE NEEDLES	Internal Diameter x External Diameter (mm)	C1	0.22 x 0.40	○	C.V. = 0.077 S.V. = 0.144	C.V. = 0.077 S.V. = 0.144	C.V. = 0.077 S.V. = 0.154	C.V. = 0.077 S.V. = 0.174	C.V. = 0.077 S.V. = 0.204
		C2	0.30 x 0.55	○		C.V. = 0.081 S.V. = 0.139	C.V. = 0.081 S.V. = 0.159	C.V. = 0.081 S.V. = 0.179	C.V. = 0.081 S.V. = 0.199
		C3	0.55 x 0.80	○		C.V. = 0.089 S.V. = 0.151	C.V. = 0.089 S.V. = 0.171	C.V. = 0.089 S.V. = 0.191	
		C4	0.80 x 1.20	○			C.V. = 0.109 S.V. = 0.141	C.V. = 0.109 S.V. = 0.161	

S.V. = Shell Volume (ml)
C.V. = Core Volume (ml)

Minimal Core Volume installation					SHELL NEEDLES				
					Internal Diameter x External Diameter (mm)				
					S1	S2	S3	S4	S5
					0.60	0.80	1.20	1.65	2.05
					x	x	x	x	x
					0.90	1.20	1.50	2.20	2.60
					○	○	○	○	○
CORE NEEDLES	Internal Diameter x External Diameter (mm)	C1	0.22 x 0.40	○	C.V. = 0.044 S.V. = 0.176	C.V. = 0.044 S.V. = 0.176	C.V. = 0.044 S.V. = 0.186	C.V. = 0.044 S.V. = 0.206	C.V. = 0.044 S.V. = 0.236
		C2	0.30 x 0.55	○		C.V. = 0.049 S.V. = 0.171	C.V. = 0.049 S.V. = 0.191	C.V. = 0.049 S.V. = 0.211	C.V. = 0.049 S.V. = 0.231
		C3	0.55 x 0.80	○		C.V. = 0.057 S.V. = 0.183	C.V. = 0.057 S.V. = 0.203	C.V. = 0.057 S.V. = 0.223	
		C4	0.80 x 1.20	○			C.V. = 0.077 S.V. = 0.173	C.V. = 0.077 S.V. = 0.193	

S.V. = Shell Volume (ml)
C.V. = Core Volume (ml)

DISCLAIMER: The contents and information contained in this brochure are intended for general marketing purposes only and should not be relied upon by any person as being complete or accurate.

MIB srl will not accept any liability suffered or incurred by any person arising out of or in connection with any reliance on the content of or information contained in this brochure.



MIB srl SOCIETÀ BENEFIT

Bologna (Italy)

info@mib40.com

COAXIAL SPINNERET

MAIN FEATURES

- Optimized geometry to minimize waste solution
- Coaxial body, made of plastic solvent resistant (different materials on request) , allows to not distort the electrostatic field making more stable and repeatable the electrospinning process.
- Mounting/Unmounting is easier with thread block improving internal cleaning and maintenance.
- Coaxial spinneret can be equipped with several configurations of core/shell needles.
- Standard tubes can be connected to coaxial spinneret making it easy to use in every research laboratory.
- Coaxial spinneret can be easily housed on the adjustable stand support which facilitates the vertical and/or horizontal position.
- Core needle sticks out the shell needle to avoid solution precipitation and which can occlude spinneret.

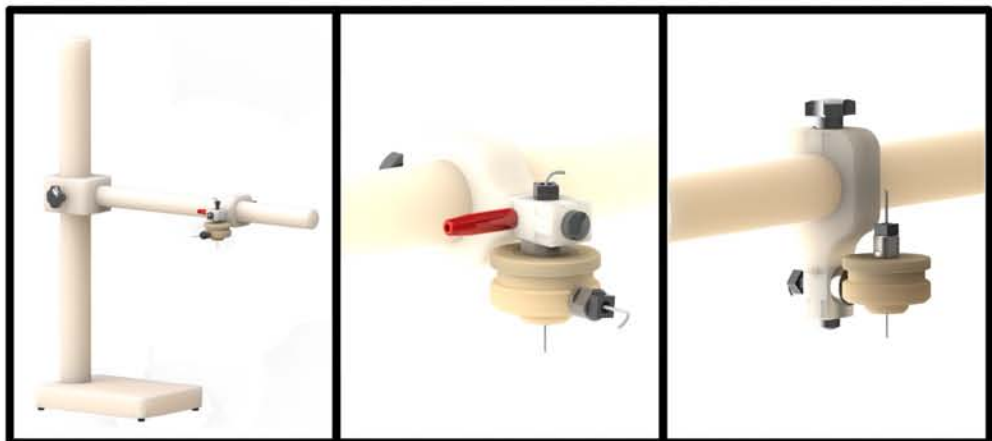

Possibility to electrify core or shell solution changing fittings position. On demand system can be customizable to electrify core and shell solution simultaneously.

CONTACT INFO

MIB srl SOCIETÀ BENEFIT

Via I. Bandiera, 14/C
40050 Monte San Pietro
(Bologna), Italia

info@mib40.com

VAT IT04073441208

DISCLAIMER: The contents and information contained in this brochure are intended for general marketing purposes only and should not be relied upon by any person as being complete or accurate.

MIB srl will not accept any liability suffered or incurred by any person arising out of or in connection with any reliance on the content of or information contained in this brochure.



MIB srl SOCIETÀ BENEFIT

Bologna (Italy)

info@mib40.com